



SYNRAD PS-401-II DC Power Supply (MEAN WELL RST-10000-48)



■ AC Power Connection

⊙ 3ϕ 3 wire / Δ 230VAC

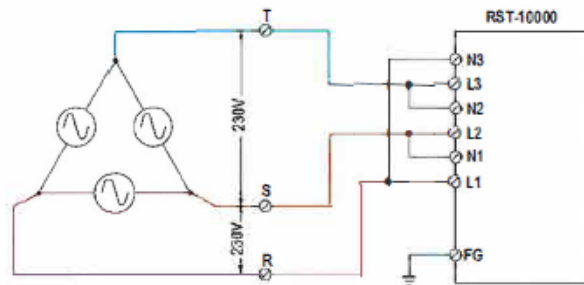

Fig 1.1

⊙ 3ϕ 4 wire / Y 400VAC

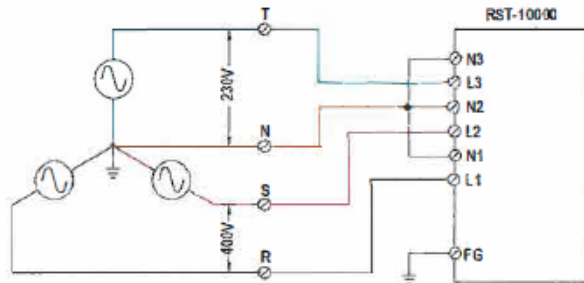

Fig 1.2

※LED Status Indicators

LED	Description
● Green(LED1)	LED on when output voltage is OK
● Red(LED2)	LED on when any protection occurs

※AC Input Terminal Pin No. Assignment (TB1)

Pin No.	Assignment	Pin No.	Assignment	Diagram	Maximum mounting torque
1	AC/L1	4	AC/N2		18Kgf-cm
2	AC/N1	5	AC/L3		
3	AC/L2	6	AC/N3		

※DIP Switch Position Assignment(DIP-SW): Please refer to the Function Manual.

Pin No.	Assignment	Diagram
1	Overload Protection (OLP)	
2	Output Current Programming (PC)	
3	Output Voltage Programming (PV)	



Dimension			
L	W	H	
540	424	83.5(2U)	mm
21.3	16.7	3.29(2U)	inch



■ Features

- 3 ψ 3-wire / Δ 196~305VAC or 3 ψ 4-wire / Y 340~530VAC wide input range
- Built-in active PFC function
- High efficiency up to 90.5%
- Forced air cooling by built-in DC fan
- Output voltage and constant current level programmable
- Active current sharing up to 20000W (1+1)
- Built-in remote ON-OFF control / Remote sense / Auxiliary power / Alarm signal
- Protections: Short circuit / Overload / Over voltage / Over temperature / Fan fail
- 5 years warranty

■ Applications

- Factory control or automation apparatus
- Test and measurement instrument
- Laser related machine
- Burn-in facility
- RF application
- Electric scooter or vehicle charger station
- Constant current source

■ GTIN CODE

MW Search: <https://www.meanwell.com/serviceGTIN.aspx>

■ Description

RST-10000 is a 10KW single output enclosed type AC/DC power supply. This series operates for the wide range three phase AC input (3 phase 3 wire / Δ 196~305VAC or 3 phase 4 wire / Y 340~530VAC) and offers the models with the DC output mostly demanded from the industry. Each model is cooled by the built-in fan with fan speed control, working for the temperature up to ,70°C. Moreover, RST-10000 provides vast design flexibility by equipping various built-in functions such as the output programming, active current sharing, remote ON-OFF control, auxiliary power, etc.

■ Model Encoding

RST - 10000- 24

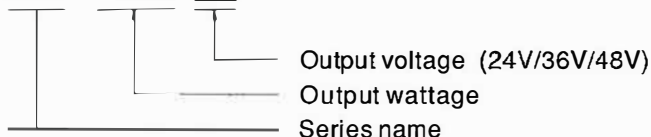



SPECIFICATION

MODEL	RST-10000-24	RST-10000-36	RST-10000-48		
OUTPUT	DC VOLTAGE	24V	36V	48V	
	RATED CURRENT	400A	276A	210A	
	CURRENT RANGE	0 ~ 400A	0 ~ 276A	0 ~ 210A	
	RATED POWER	9600W	9936W	10080W	
	RIPPLE & NOISE (max.) Note.2	150mVp-p	200mVp-p	200mVp-p	
	VOLTAGE ADJ. RANGE	23.5 ~ 28.8V	35 ~ 43.2V	47 ~ 57.6V	
		Can be adjusted via built-in potentiometer			
	VOLTAGE TOLERANCE Note.3	± 1.0%	± 1.0%	± 1.0%	
	LINE REGULATION	± 0.5%	± 0.5%	± 0.5%	
	LOAD REGULATION	± 0.5%	± 0.5%	± 0.5%	
SETUP, RISE TIME	2200ms, 80ms at full load				
HOLD UP TIME (Typ.)	20ms / 230VAC at 75% load 14ms / 230VAC at full load				
INPUT	VOLTAGE RANGE	3 ϕ 3-wire / Δ 196 ~ 305VAC or 3 ϕ 4-wire / Y 340 ~ 530VAC			
	FREQUENCY RANGE	47 ~ 63Hz			
	POWER FACTOR (Typ.)	0.95/230VAC(400VAC) at full load			
	EFFICIENCY (Typ.)	88.5%	89.5%	90.5%	
	AC CURRENT (Typ.)	30A/230VAC(3 ϕ 3-wire / Δ)	18A/400VAC(3 ϕ 4-wire / Y)		
	INRUSH CURRENT (Typ.)	150A/230VAC(3 ϕ 3-wire / Δ)	100A/400VAC(3 ϕ 4-wire / Y)		
	LEAKAGE CURRENT	<7mA/ Δ 305VAC(Y 530VAC)			
PROTECTION	OVERLOAD(OLP)	100 ~ 112% rated output power User selectable continuous constant current limiting or constant current limiting with delay shutdown after 5 seconds, re-power on to recover			
	OVER VOLTAGE	30 ~ 33.6V	45 ~ 50.4V	60 ~ 67.2V	
		Protection type : Shut down o/p voltage, re-power on to recover			
	OVER TEMPERATURE	Shut down o/p voltage, recovers automatically after temperature goes down			
FUNCTION	REMOTE SENSE	Compensate voltage drop on the load wiring up to 0.3V. Please refer to the Function Manual.			
	CURRENT SHARING	Up to 20000W or (1+1) units. Please refer to the Function Manual.			
	AUXILIARY POWER	12V@0.1A(Only for Remote ON/OFF control)			
	REMOTE ON-OFF CONTROL	Please refer to the Function Manual.			
	OUTPUT VOLTAGE PROGRAMMABLE	Adjustment of output voltage is allowable to between 20 ~ 120% of nominal output voltage. Please refer to the Function Manual.			
	CONSTANT CURRENT LEVEL PROGRAMMABLE	Adjustment of constant current level is allowable to between 20 ~ 100% of rated current. Please refer to the Function Manual.			
	ALARM SIGNAL OUTPUT	AC fail, DC OK, fan fail, OTP. Please refer to the Function Manual.			
ENVIRONMENT	WORKING TEMP.	-30 ~ +70°C (Refer to "Derating Curve")			
	WORKING HUMIDITY	20 ~ 90% RH non-condensing			
	STORAGE TEMP., HUMIDITY	-40 ~ +85°C, 10 ~ 95% RH non-condensing			
	TEMP. COEFFICIENT	± 0.03%/°C (0 ~ 50°C)			
	VIBRATION	10 ~ 500Hz, 2G 10min./1cycle, 60min. each along X, Y, Z axes			
SAFETY & EMC (Note 6)	SAFETY STANDARDS	UL62368-1, CAN/CSA C22.2 No. 62368-1, TUV BS EN/EN62368-1, IS13252(Part1)/IEC60950-1, EAC TP TC 004 approved			
	WITHSTAND VOLTAGE Note.4	I/P-O/P:3KVAC I/P-FG:2KVAC O/P-FG:0.5KVAC			
	ISOLATION RESISTANCE Note.4	I/P-O/P, I/P-FG, O/P-FG:100M Ohms / 500VDC / 25°C / 70% RH			
	EMC EMISSION	Parameter	Standard	Test Level / Note	
		Conducted	BS EN/EN55032 (CISPR32)	Class A	
		Radiated	BS EN/EN55032 (CISPR32)	Class A	
		Harmonic Current	BS EN/EN61000-3-2	-----	
		Voltage Flicker	BS EN/EN61000-3-3	-----	
	EMC IMMUNITY	BS EN/EN55035, BS EN/EN61000-6-2			
		Parameter	Standard	Test Level / Note	
		ESD	BS EN/EN61000-4-2	Level 3, 8KV/air ; Level 2, 4KV/contact	
		Radiated	BS EN/EN61000-4-3	Level 3	
		EFT / Burst	BS EN/EN61000-4-4	Level 3	
		Surge	BS EN/EN61000-4-5	Level 4, 4KV/Line-Earth ; Level 3, 2KV/Line-Line	
Conducted		BS EN/EN61000-4-6	Level 3		
Magnetic Field		BS EN/EN61000-4-8	Level 4		
Voltage Dips and Interruptions		BS EN/EN61000-4-11	>95% dip 0.5 periods, 30% dip 25 periods, >95% interruptions 250 periods		
OTHERS	MTBF	147.5K hrs min. Telcordia SR-332 (Bellcore) ; 17.1K hrs min. MIL-HDBK-217F (25°C)			
	DIMENSION	540*424*83.5mm (L*W*H)			
	PACKING	23.5Kg; 1pcs/23.5Kg/2.82CUFT			
NOTE	<p>1. All parameters NOT specially mentioned are measured at Δ230VAC(Y 400VAC) input, rated load and 25°C of ambient temperature.</p> <p>2. Ripple & noise are measured at 20MHz of bandwidth by using a 12" twisted pair-wire terminated with a 0.1μf & 47μf parallel capacitor.</p> <p>3. Tolerance : includes set up tolerance, line regulation and load regulation.</p> <p>4. During withstand voltage and isolation resistance testing, the screw "A" shall be temporarily removed, and shall be installed back after the testing.</p> <p>5. There is high possibility to trigger the floating over voltage protection when PV voltage is trimmed from a high voltage level to a lower voltage level at light load or no load condition. It is suggested that turn off the power supply and set PV voltage to the lowest level, then adjust output voltage to a desired value.</p> <p>6. The power supply is considered a component which will be installed into a final equipment. All the EMC tests are been executed by mounting the unit on a 1300mm*900mm metal plate with 2mm of thickness. The final equipment must be re-confirmed that it still meets EMC directives. For guidance on how to perform these EMC tests, please refer to "EMI testing of component power supplies." (as available on http://www.meanwell.com)</p> <p>7. The ambient temperature derating of 3.5°C/1000m with fanless models and of 5°C/1000m with fan models for operating altitude higher than 2000m(6500ft).</p> <p>※ Product Liability Disclaimer : For detailed information, please refer to https://www.meanwell.com/serviceDisclaimer.aspx</p>				

Block Diagram

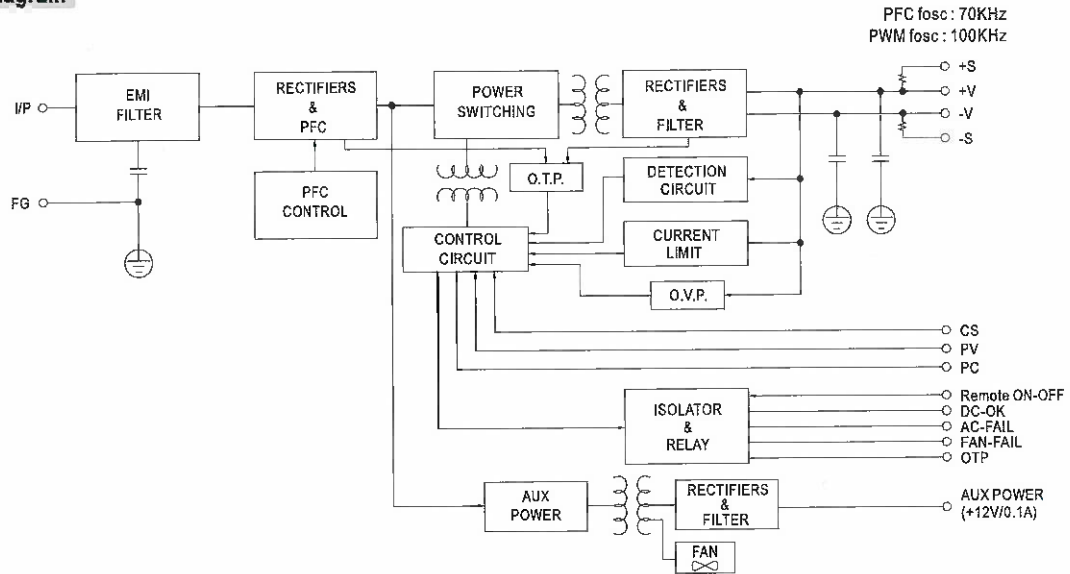

Derating Curve

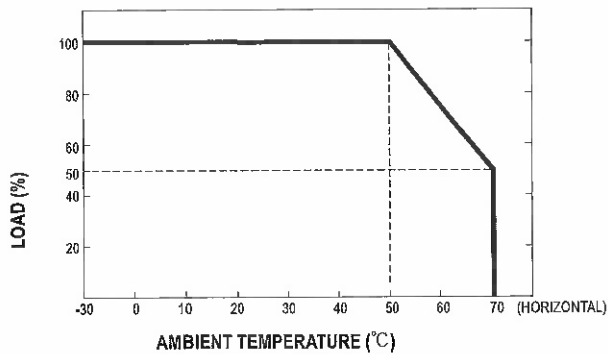

MODEL	24V	36V	48V
INPUT			
△ 196~305VAC	9600W	9936W	10080W
340~530VAC	400A	276A	210A

Static Characteristics

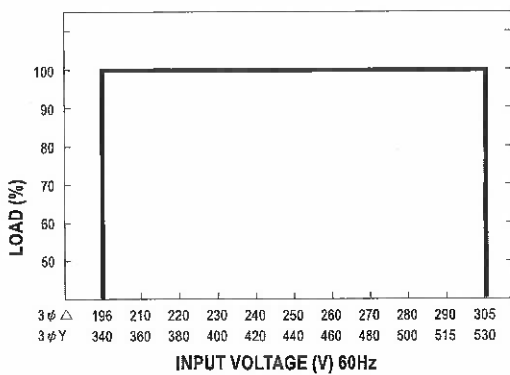

Efficiency vs Load (48V Model)

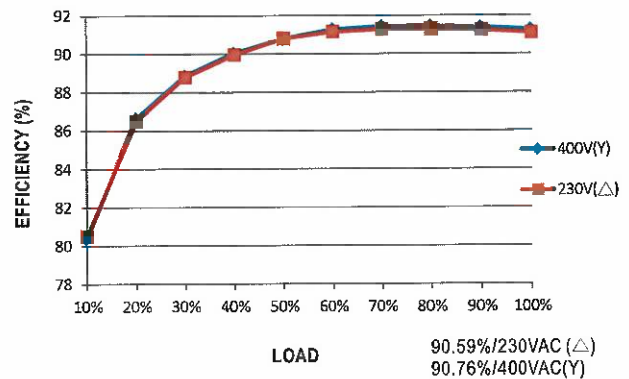

■ AC Power Connection

⊙ 3 φ 3 wire / Δ 230VAC

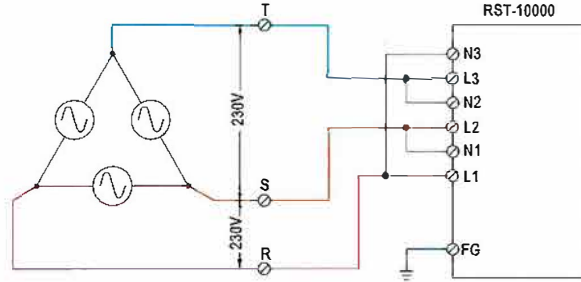

Fig 1.1

⊙ 3 φ 4 wire / Y 400VAC

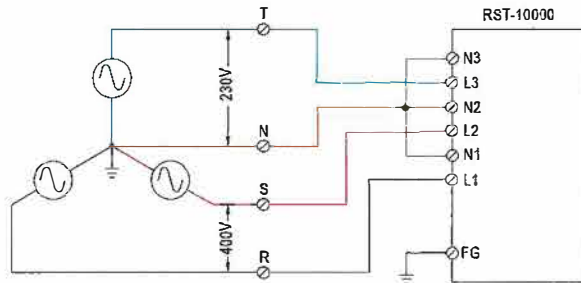

Fig 1.2

■ Function Manual

1. Remote Sense

- ※ The remote sense function compensates the voltage drop on the cable, between the power supply and the load, up to 0.3V.
- ※ If the remote sense function is not required, +S and +V of the output terminal, as well as -S and -V, need to be connected to be free from noise and interference. (+S and +V of the output terminal, -S and -V are connected as factory default setting)

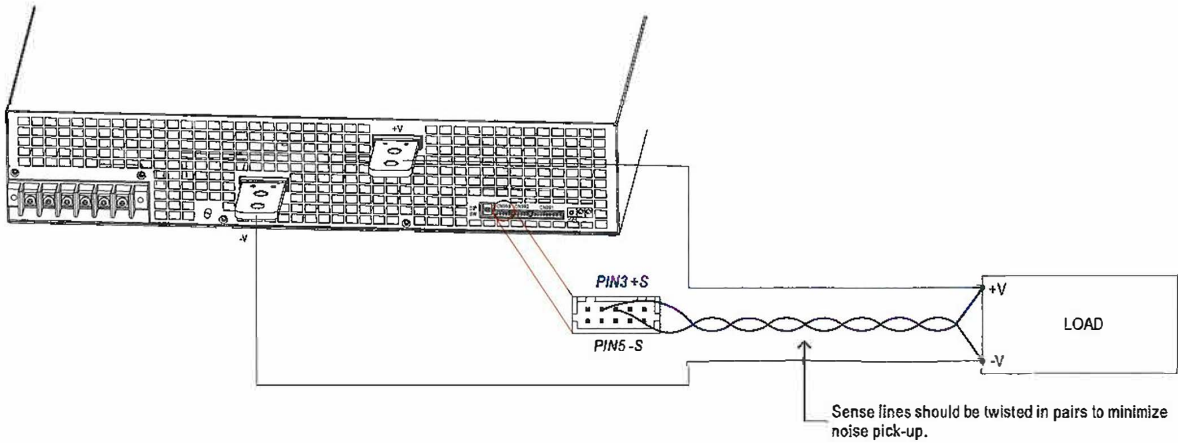

Fig 1.1

2.Voltage Adjustment

(1)by potentiometer (SVR)

(a)Have the DIP switch position-3 set as



(b)Output voltage can be trimmed by SVR.

(2)by Output Voltage Programming*

(a)Have the DIP switch position-3 set as



(b)The output voltage can be trimmed to 20~120% of the nominal voltage by applying EXTERNAL VOLTAGE between PV+ and PV- on CN992 or CN993.

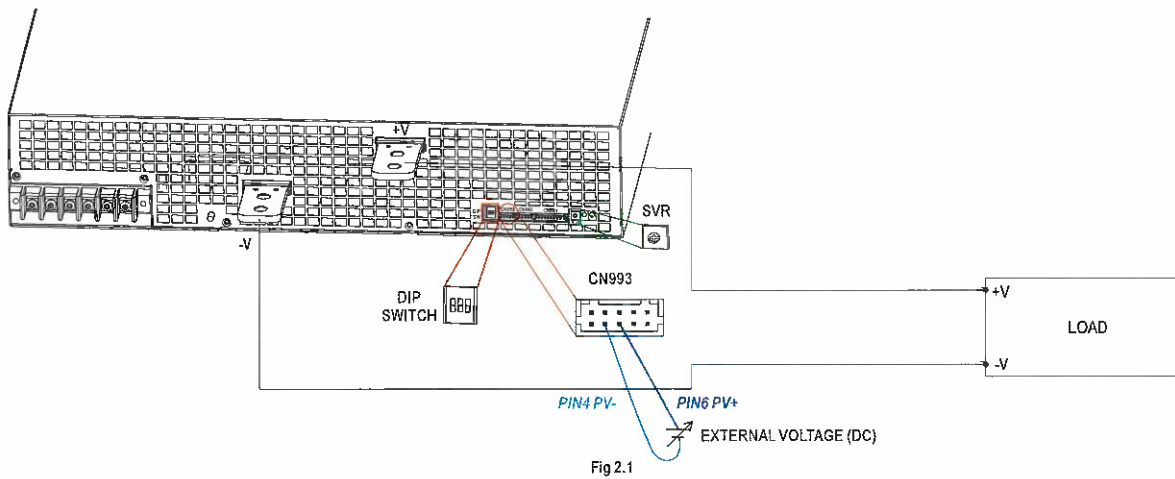

Fig 2.1

⊙+S and +V, as well as -S and -V, need to be connected as factory default setting

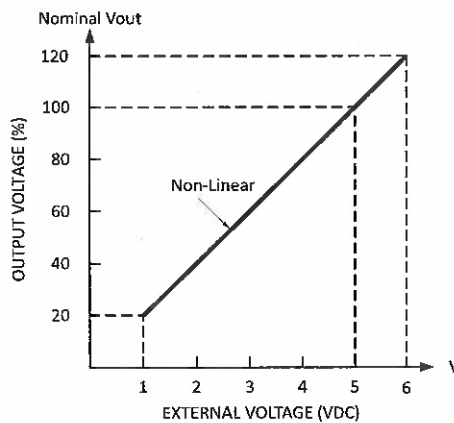

Fig 2.2

*: or, PV/remote voltage programming / remote adjust / margin programming / dynamic voltage trim.

3. Current Adjustment

(1) Default Overload Protection (OLP) value

- (a) Have the DIP switch position-2 set as
- (b) Output current is set default value.



(2) by Constant Current Level Programming**

- (a) Have the DIP switch position-2 set as
- (b) The constant current level can be trimmed to 20~100% of the rated current by applying EXTERNAL VOLTAGE between PC+ and PC- on CN992 or CN993.

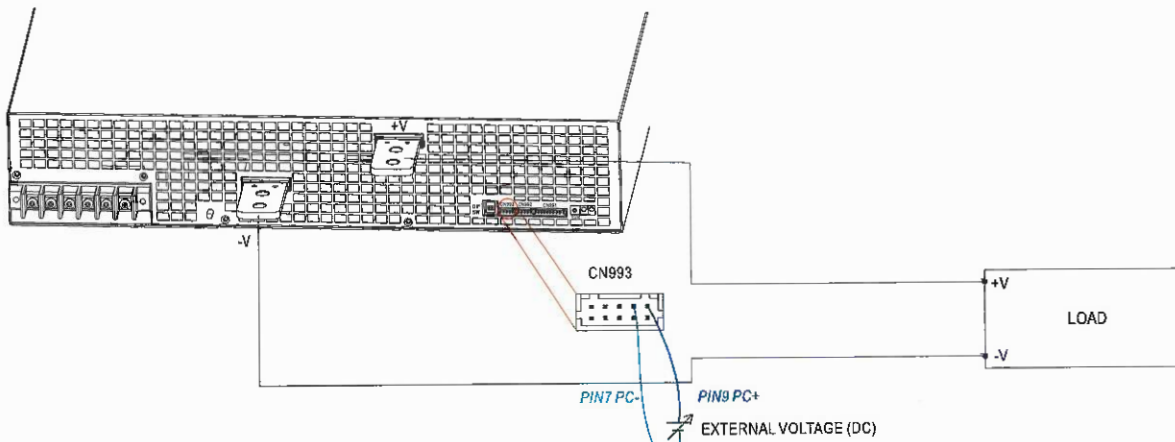

Fig 3.1

⊙+S and +V, as well as -S and -V, need to be connected as factory default setting

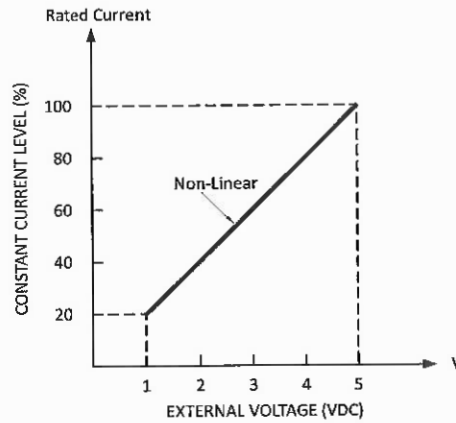

Fig 3.2

**; or, PC/remote current programming / dynamic current trim.

4. Select Overload Protection (OLP) Mode

(1) Continuous Constant Current mode

Have the DIP switch position-1 set as ,and RST-10000 will work in continuous constant current mode when the output is overloaded and the output voltage is greater than 50% of the rated output voltage.

(2) Delay Shutdown mode

Have the DIP switch position-1 set as ,and RST-10000 will shut down after 5 seconds of constant current operation, when the output is overloaded or short-circuited.

5. Remote ON-OFF Control

※ The power supply can be turned ON-OFF by using the "Remote ON-OFF" function.

Between Remote ON-OFF(CN992 or CN993 pin10) and 12V-AUX(CN991 pin1)	Output Status
Switch close (Short)	power supply ON
Switch open (Open)	power supply OFF

Table 5.1

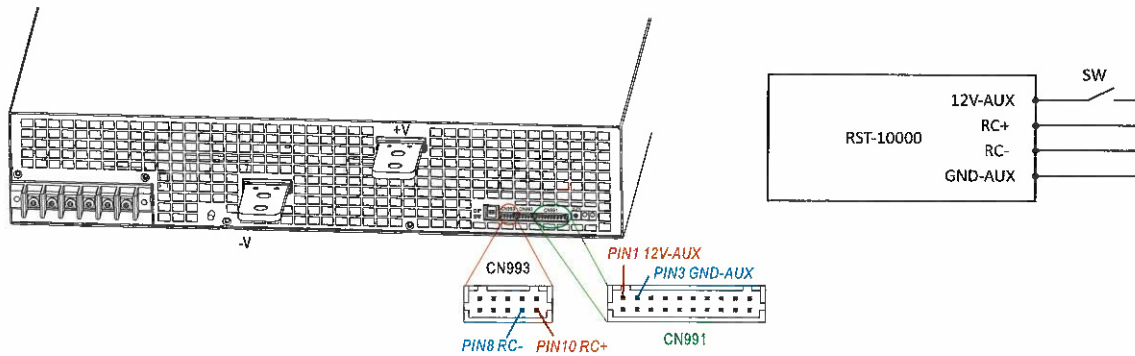

Fig 5.1

6. Alarm Signal Output

※ There are 4 alarm signals on CN991, and each signal can select two types of output circuit.

(1) Relay contact output (OTP1, OTP1-GND); (DC-OK1, DC-OK1-GND); (AC-FAIL1-GND, AC-FAIL1); (FAN-FAIL1-GND, FAN-FAIL1))

Normally open contact. "Short" when the alarm arises. Relay contact rating(maximum) is 30V/1A resistive.

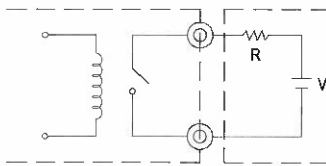

Fig 6.1

(2) Open collector output (DC-OK2-GND, DC-OK2); (AC-FAIL2-GND, AC-FAIL2); (OTP2, OTP2-GND); (FAN-FAIL2, FAN-FAIL2-GND))

An external voltage source is required for this function that is shown in Fig 6.2. These signals are isolated from output. The maximum sink current is 10mA and the maximum external voltage is 20V (there is a built-in 24V zener diode in inner circuitry).

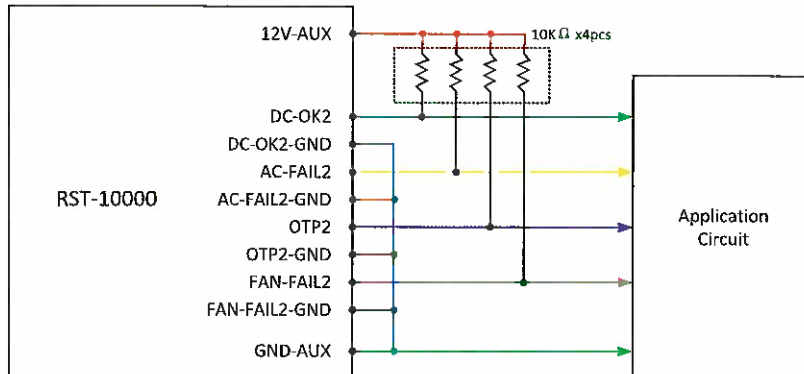
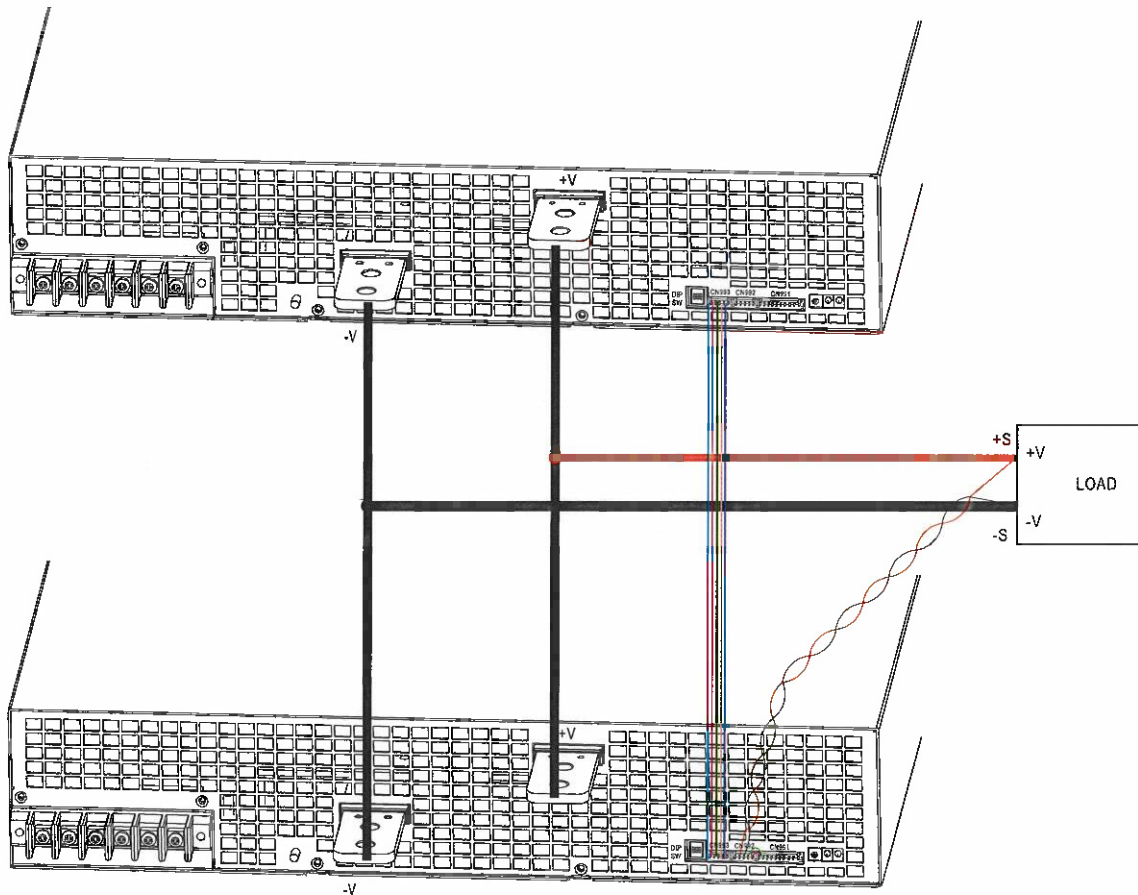

Fig 6.2

7. Current Sharing

RST-10000 has the built-in active current sharing function and can be connected in parallel, up to 2 units, to provide higher output power as exhibited below :

- ※ The voltage difference among each output should be minimized that less than 0.2V is required.
- ※ The total output current must not exceed the value determined by the following equation.
 Maximum output current at parallel operation=(The rated current per unit) \times (Number of unit) \times 0.9
- ※ When the total output current is less than 5% of the total rated current, or say (5% of Rated current per unit) \times (Number of unit) the current shared among units may not be fully balanced.



- ◎ +S,-S and CS+, CS- and RC+, RC- are connected mutually in parallel.
- ◎ When the remote sense function is used in parallel operation, the sensing wire must be connected only to the master unit.
- ◎ Wires of the remote sense function should be kept at least 30 cm from input wires.

Mechanical Specification

Case No.234A Unit:mm

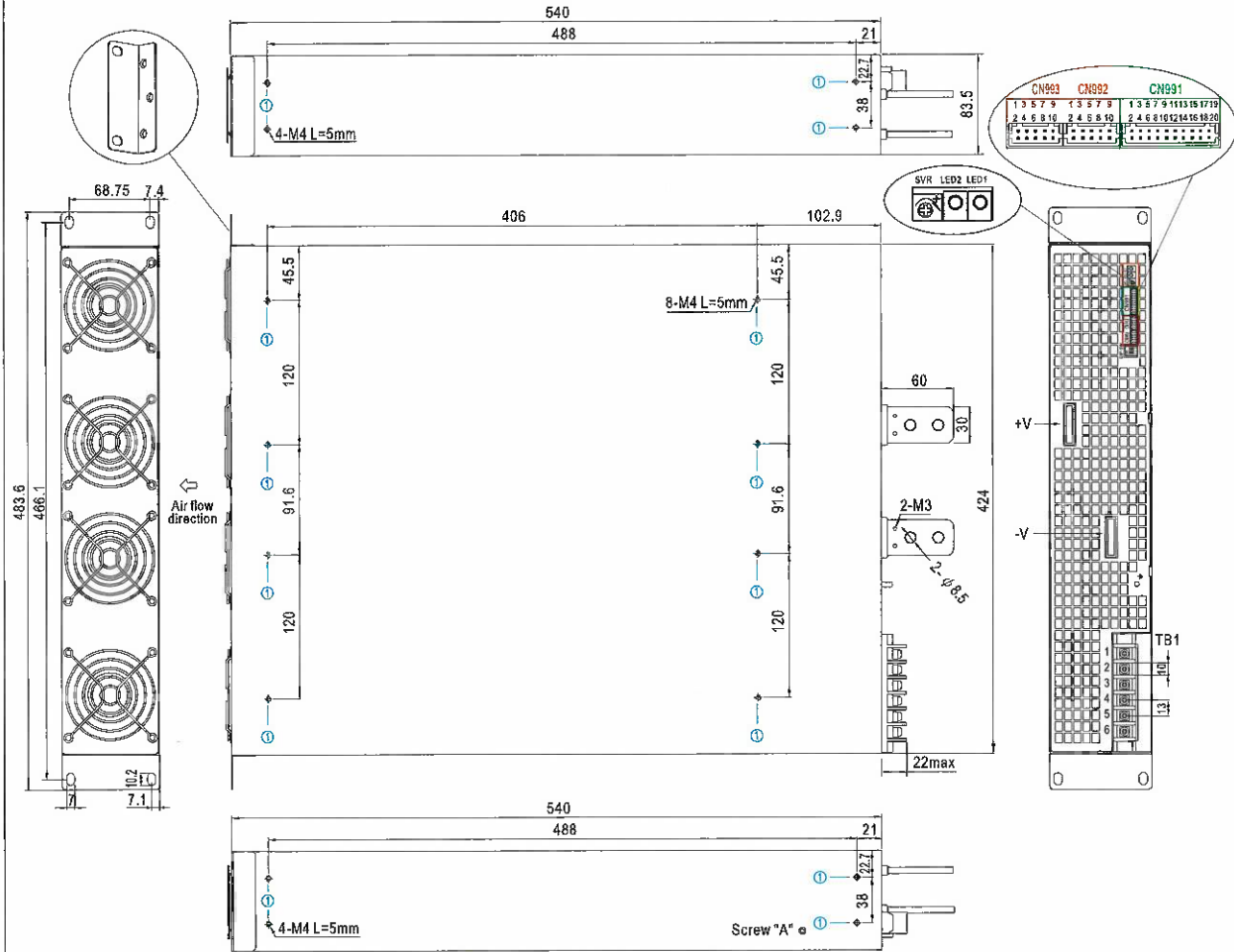

※ Mounting Instruction

Hole No.	Recommended Screw Size	MAX. Penetration Depth L	Recommended mounting torque
①	M4	5mm	7~10Kgf-cm

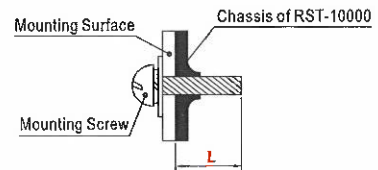

※ Control Pin No. Assignment (CN992,CN993) : HRS DF11-10DP-2DS or equivalent

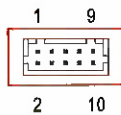

Mating Housing	HRS DF11-10DS or equivalent
Terminal	HRS DF11-10SC or equivalent

◎ CN992 and CN993 are connected internally.

Pin No.	Function	Description
1	CS-	Current sharing signal. When units are connected in parallel, the CS pins of the units should be connected to allow current balance between units.
2	CS+	
3	+S	Positive sensing for remote sense.
4	PV-	Connection for output voltage programming.
6	PV+	
5	-S	Negative sensing for remote sense.
7	PC-	Connection for output current programming.
9	PC+	
8	RC-	The output can be turned ON-OFF in association with RC+ and RC-.
10	RC+	

※ Control Pin No. Assignment (CN991) : HRS DF11-20DP-2DS or equivalent

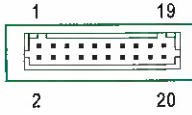

Mating Housing	HRS DF11-20DS or equivalent
Terminal	HRS DF11-20SC or equivalent

Pin No.	Function	Description
1	12V-AUX	Auxiliary voltage output, 11.4~12.6V, referenced to pin 3(GND-AUX). The maximum load current is 0.1A. This output is not controlled by the "Remote ON/OFF" function.
2	DC-OK2-GND	Alarm signal of DC-OK.
4	DC-OK2	Open collector signal. Low when the PSU turns on. The maximum sink current is 10mA and the maximum external voltage is 20V.
3	GND-AUX	Auxiliary voltage output GND. The signal return is isolated from the output terminals (+V & -V).
5	+V(signal)	Positive output voltage. For local sense only ; it cannot be connected directly to the load.
6	AC-FAIL2-GND	Alarm signal of AC fail.
8	AC-FAIL2	Open collector signal. Low when the PSU input voltage is too low. The maximum sink current is 10mA and the maximum external voltage is 20V.
7	-V(signal)	Negative output voltage. For local sense only ; it cannot be connected directly to the load.
9	OTP2	Alarm signal of OTP.
11	OTP2-GND	Open collector signal. Low when the PSU over temperature protection occurs. The maximum sink current is 10mA and the maximum external voltage is 20V.
10	FAN-FAIL2	Alarm signal of fan fail.
12	FAN-FAIL2-GND	Open collector signal. Low when the internal fan fails. The maximum sink current is 10mA and the maximum external voltage is 20V.
13	OTP1	Alarm signal of OTP.
15	OTP1-GND	Normally open contact. "Short" when the PSU over temperature protection occurs. Relay contact rating(maximum) is 30V/1A resistive.
14	DC-OK1	Alarm signal of DC-OK.
16	DC-OK1-GND	Normally open contact. "Short" when the PSU turns on. Relay contact rating(maximum) is 30V/1A resistive.
17	AC-FAIL1-GND	Alarm signal of AC-fail.
19	AC-FAIL1	Normally open contact. "Short" when the PSU input voltage is too low. Relay contact rating(maximum) is 30V/1A resistive.
18	FAN-FAIL1-GND	Alarm signal of fan fail.
20	FAN-FAIL1	Normally open contact. "Short" when the internal fan fails. Relay contact rating(maximum) is 30V/1A resistive.

※LED Status Indicators

LED	Description
● Green(LED1)	LED on when output voltage is OK
● Red(LED2)	LED on when any protection occurs

※AC Input Terminal Pin No. Assignment (TB1)

Pin No.	Assignment	Pin No.	Assignment	Diagram	Maximum mounting torque
1	AC/L1	4	AC/N2		18Kgf-cm
2	AC/N1	5	AC/L3		
3	AC/L2	6	AC/N3		

※DIP Switch Position Assignment(DIP-SW): Please refer to the Function Manual.

Pin No.	Assignment	Diagram
1	Overload Protection (OLP)	
2	Output Current Programming (PC)	
3	Output Voltage Programming (PV)	

■ Installation Manual

Please refer to : <http://www.meanwell.com/manual.html>